

Ethernet Adapter

User Guide

To re-order quote part number:	HD0333
Revision:	2.1.0
Revision date:	May 2012

Copyright

Neither the whole or any part of the information contained in nor the product described in this documentation may be adapted or reproduced in any material form except with the prior written approval of Hydronix Limited, hereinafter referred to as Hydronix.

© 2012

Hydronix Limited
7 Riverside Business Centre
Walnut Tree Close
Guildford
Surrey GU1 4UG
United Kingdom

All rights reserved

CUSTOMER RESPONSIBILITY

The customer in applying the product described in this documentation accepts that the product is a programmable electronic system which is inherently complex and which may not be completely free of errors. In doing so the customer therefore undertakes responsibility to ensure that the product is properly installed commissioned operated and maintained by competent and suitably trained persons and in accordance with any instructions or safety precautions made available or good engineering practice and to thoroughly verify the use of the product in the particular application.

ERRORS IN DOCUMENTATION

The product described in this documentation is subject to continuous development and improvement. All information of a technical nature and particulars of the product and its use including the information and particulars contained in this documentation are given by Hydronix in good faith.

Hydronix welcomes comments and suggestions relating to the product and this documentation

ACKNOWLEDGEMENTS

Hydronix, Hydro-Probe, Hydro-Mix, Hydro-Skid, Hydro-View and Hydro-Control are Registered Trade Marks of Hydronix Limited

Hydronix Offices

UK Head Office

Address: 7 Riverside Business Centre
Walnut Tree Close
Guildford
Surrey
GU1 4UG

Tel: +44 1483 468900

Fax: +44 1483 468919

Email: support@hydronix.com
sales@hydronix.com

Website: www.hydronix.com

North American Office

Covers North and South America, US territories, Spain and Portugal

Address: 692 West Conway Road
Suite 24, Harbor Springs
MI 47940
USA

Tel: +1 888 887 4884 (Toll Free)

+1 231 439 5000

Fax: +1 888 887 4822 (Toll Free)

+1 231 439 5001

European Office

Covers Central Europe, Russia and South Africa

Tel: +49 2563 4858

Fax: +49 2563 5016

French Office

Tel: +33 652 04 89 04

Revision history

Revision No.	Date	Description of change
1.0.0	December 2007	First Draft
2.0.0	January 2008	First edition released
2.1.0	May 2012	Product references updated

Table of Contents

Chapter 1 Introduction.....	13
Chapter 2 Connecting with Sensors	15
1 Installation	15
2 Connections	17
3 Indicator Lights	18
4 Programming.....	19
Chapter 3 Connecting with Hydro-Control VI.....	21
1 Introduction.....	21
2 Installation	21
3 Connecting with Hydro-Control VI.....	23
Chapter 4 Configuring the Ethernet Adapter.....	25
1 Ethernet Adapter defaults	25
2 Finding an Ethernet Adapter automatically	25
3 Adding an Ethernet Adapter manually	26
4 Changing the Ethernet Adapter IP Address	27
5 Remote (Internet) Connection.....	27
Chapter 5 Technical Specifications.....	29
1 EA01 Ethernet Adapter	29
2 EPA01 Ethernet Power Adapter.....	29
3 EPI01 Ethernet Power Injector	29
4 Terminal Identification	30
Chapter 6 Fault Finding.....	33
1 Ethernet Adapter EA01	33
2 Ethernet Power Adapter EPA01.....	33
3 Ethernet Power Injector EPI01	34
Appendix A Declaration of Conformity	35

Table of Figures

Figure 1: Ethernet Adapter Kit Connections	13
Figure 2: Connections for Ethernet Adapter only.....	15
Figure 3: Connections for Ethernet Adapter and Power Adapter	16
Figure 4: Maximum number of sensor connections dependent upon ambient temperature	17
Figure 5: Connecting the Ethernet Adapter to Hydro-Control VI	21
Figure 6: Connecting the Ethernet Adapter to Hydro-Control VI with Power Over Ethernet Option	22
Figure 7: EA01 Terminal Identification	30
Figure 8: EPA01 Terminal Identification	31

Kit Contents



A – Ethernet Adapter – EA01

B – Ethernet Power Adapter – EPA01

C – Ethernet Power Injector – EPI01

D – IEC Mains Cable

E – Ethernet Patch Cables x 3

Order Options:

Ethernet Adapter Kit

Part Number: EAK01

Comprises:

Ethernet Adapter, Ethernet Patch Cable (0.5m), User Guide, CD with Hydro-Com software and User Guide

Use:

Use with external 24V power supply

Ethernet Power Adapter Kit:

Part Number: EPK01

Comprises:

All the above plus Ethernet Power Adapter, Power Injector, IEC mains cable and 2 additional Ethernet Patch Cables

Use:

Provides power and Ethernet connection over standard CAT5e cable

The Hydronix Ethernet Adapter provides a simple method of network enabling Hydronix products. The Adapter is a small DIN-rail mounted unit that converts packets received over an Ethernet (TCP/IP) network to RS485 or RS232. This enables a host PC elsewhere on the network to communicate with sensors using Hydronix Hydro-Com software. Remote configuration and control of a Hydro-Control VI unit is also possible.

An option of using Power over Ethernet is available via a second small DIN-rail module to eliminate the need for a local 24V supply for the sensors.



Figure 1: Ethernet Adapter Kit Connections

1 Installation

Depending on the installation option chosen, the system should be set up as shown in the diagrams below. Terminal identification for each module is shown later in this chapter. In order to maintain compliance with the relevant product directives, this equipment should only be installed and used with the approved components supplied by Hydronix. Unauthorised modifications to the units could void the units compliance and invalidate the users right to use the equipment.

1.1 Ethernet Adapter Only (EA01)

The most basic setup uses only the Ethernet Adapter and is arranged as shown below:

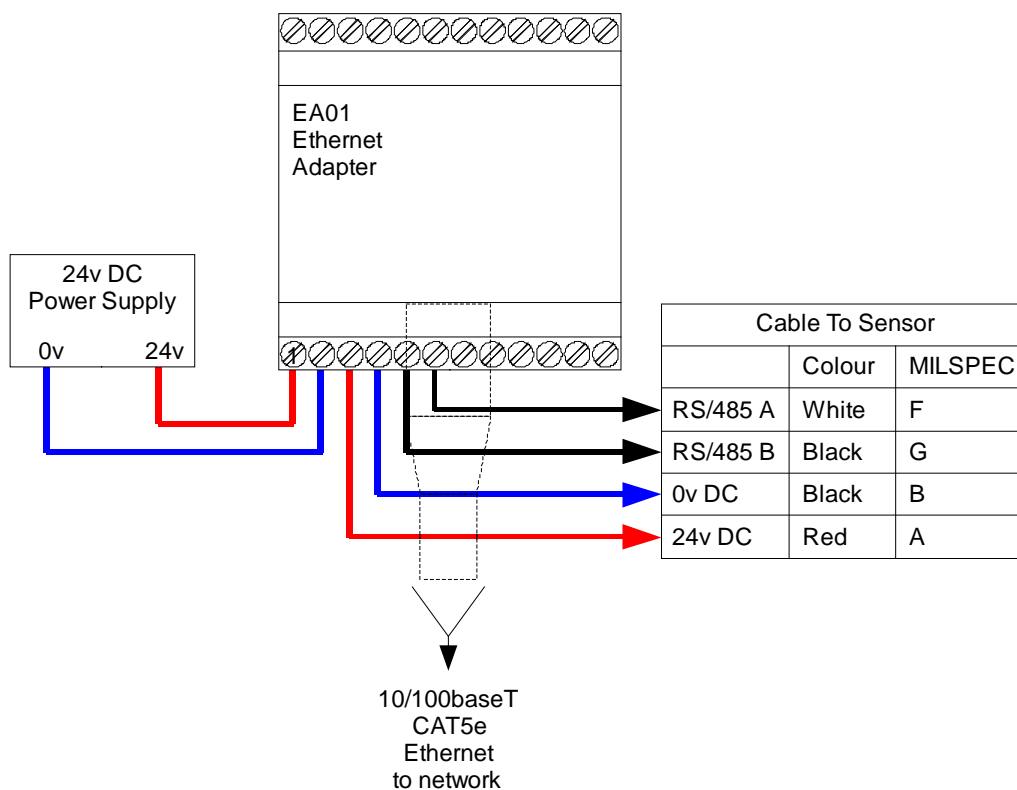

Figure 2: Connections for Ethernet Adapter only

1.1.1 Location of the Ethernet Adapter (EA01)

The Ethernet Adapter should be mounted in the wiring junction box as close to the sensors as possible, and protected from water and excessive dust. The Ethernet Adapter (EA01) should be installed in such a manner as to prevent electro-static discharge to the Ethernet "IN" port. Such a discharge may cause the unit to lock up and require a power "OFF – ON" cycle to restore performance.

Connect the Ethernet drop cable from the network connection to the Ethernet port of the Adapter. Connect a 24V dc supply to the 24V+ and 0V input terminals of the Ethernet Adapter, ensuring that the power supply and wire is of a sufficient power rating to carry the power for the number of sensors connected

Connect the RS485 sensor cable to the Ethernet Adapter outputs, taking care to note the recommendations in the RS485 Wiring Recommendations later in the chapter.

1.2 Power over Ethernet (EPK01)

To eliminate the need for a local 24V supply for the adapter and sensors, the optional Power over Ethernet kit can be used. The arrangement is as shown below:

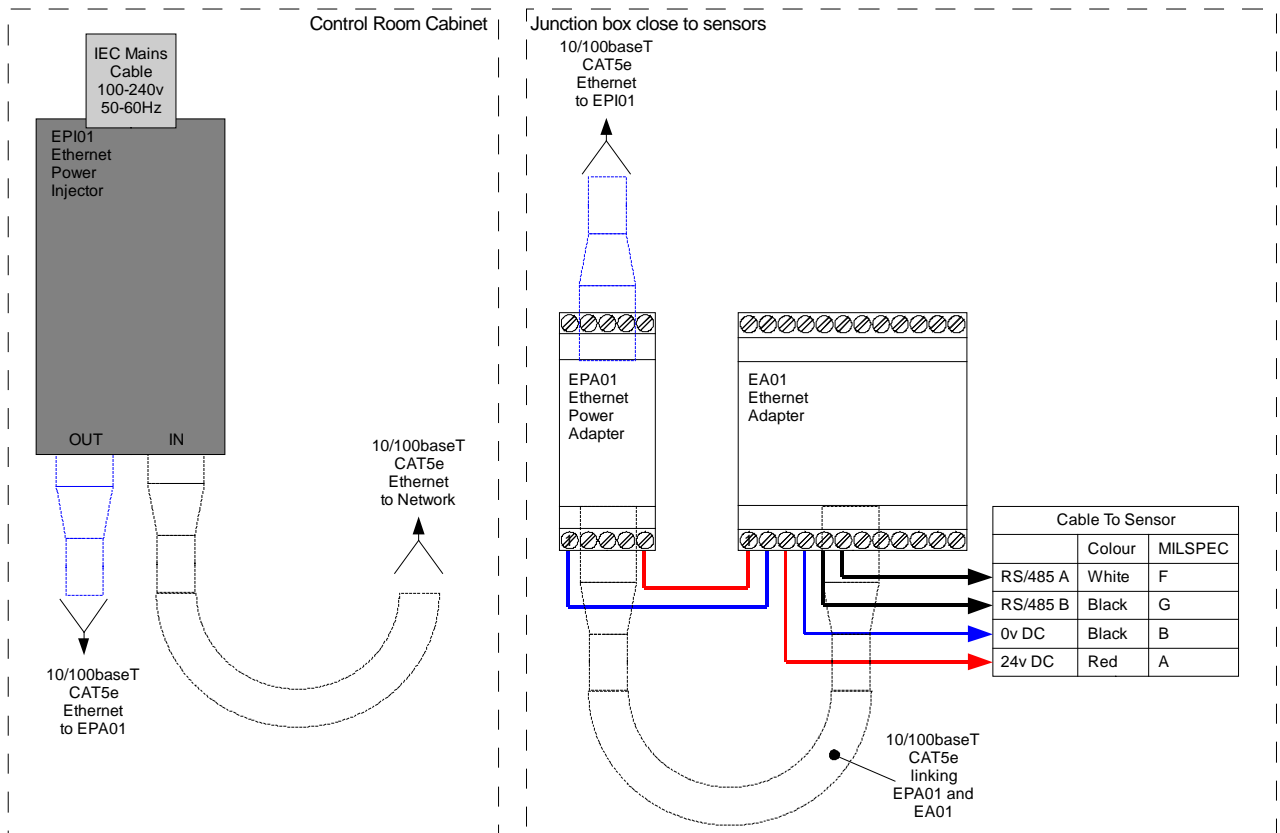

Figure 3: Connections for Ethernet Adapter and Power Adapter

1.2.1 Location of the Ethernet Power Adapter (EPA01)

The Power Adapter Module (EPA01) should be mounted in the wiring junction box close to the sensors and beside the Ethernet Adapter, protected from water and excessive dust. Connect the Ethernet drop cable from the router to the IN port of the Power Adapter. This cable carries both the power and the Ethernet communications signals. Connect a short Ethernet cable from the OUT port of the Power Adapter to the Ethernet port on the Adapter. This cable carries only the Ethernet communications. Connect short insulated wires from the 24V+ and 0V outputs of the Power Adapter to the 24V+ and 0V inputs of the Ethernet Adapter, ensuring that the wire is of sufficient power rating to carry the power for the number of sensors connected.

Connect the RS485 sensor cable to the Ethernet Adapter outputs, taking care to note the recommendations in the RS485 Wiring Recommendations later in this chapter.

Sufficient ventilation and cooling should be employed to keep the air temperature around the unit to a suitable level for the number of sensors being powered. The diagram below shows the number of sensors that can be used at different air temperatures for each sensor type.

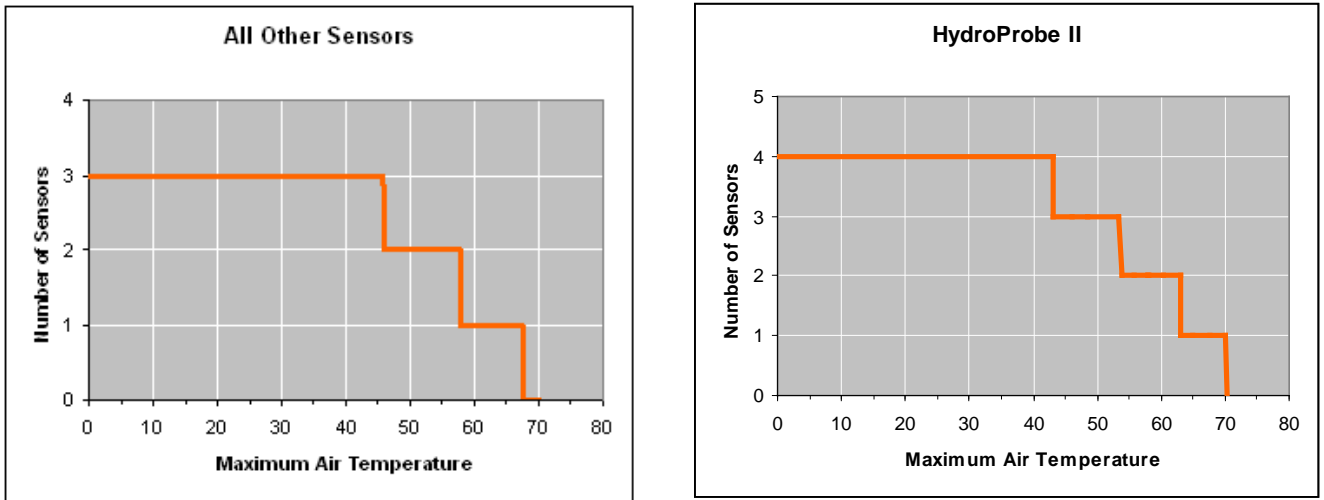

Figure 4: Maximum number of sensor connections dependent upon ambient temperature

NOTE: Operation above these limits may cause premature failure of the unit.

1.2.2 Location of the Power Injector Module (EPI01)

The Power Injector Module (EPI01) should ideally be located in the computer room or network cabinet close to the router. Identify which drop cable runs to the sensor location, and using a short patch cable insert the Power Injector into that cable, connecting the port labelled IN to the router output and the port labelled OUT to the drop cable. Connect a 240V or 110V mains supply to the Power Injector.

Note: The Power Injector Module can supply sufficient power for up to three Hydronix sensors (or 4 Hydro-Probe II sensors). If more sensors are to be connected to the network, then a separate power supply local to the sensors should be used instead of the Power over Ethernet solution.

2 Connections

2.1 Wiring Connections

2.1.1 Ethernet Adapter sensor connections:

Ethernet Adapter Terminal	Signal Description	MIL Spec pin number on sensor	Wire Colour in standard Hydronix 0090A cable
1	24V + input		
2	0V input		
3	24V + to sensor	A	Red
4	0V to sensor	B	Black
5	RS485 B	G	Black
6	RS485 A	F	White

The white and black are from one twisted pair and the red and black from another.

2.1.2 Ethernet Power Adapter connections:

Ethernet Power Adapter Terminal	Signal Description
1	0V output
5	24V + output

2.2 RS-485 Wiring Recommendations

The performance and reliability of a RS485 network can depend significantly on the quality and design of the wiring used. It is recommended to use 24AWG twisted pairs with a characteristic impedance (Z_0) of 100R – 120R. Ideally, sensors on a RS485 network should be connected in a daisy chain arrangement, as shown here:



This arrangement uses just one of the sets of sensor outputs on the Ethernet Adapter. In practice, this arrangement is hard to achieve, so sensors may be wired using very short stubs:

Although the Ethernet Adapter has multiple sets of sensor outputs, wiring in a star configuration with each sensor wired to an output set should be avoided if at all possible.

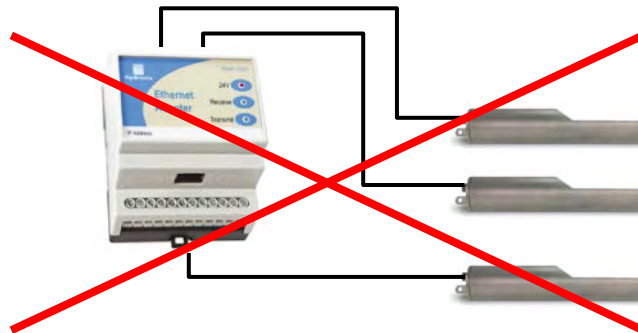

3 Indicator Lights

The Ethernet Power Adapter unit (EPA01) has a single red indicator light on the top, which indicates that it is supplying power. It must be connected to an Ethernet cable with an 802.11af compliant Power Injector supplying it.

The Ethernet Adapter (EA01) has three indicator lights on the top. The red indicator illuminates when a suitable 24V supply is connected. The transmit indicator light blinks when data is received by the Adapter and is being sent to the sensors. The receive indicator light blinks when data is received from the sensors and is being sent over the Ethernet to the host system.

Additionally, the green indicator light above the network connector indicates that a network connection has been established, and the yellow indicator blinks when network data is sent or received

4 Programming

An installation using the Ethernet Adapter packs the messages sent from a Host to the Sensor into an Ethernet data packet, which is then unpacked by the Ethernet Adapter and converted into RS485 voltage levels. If a custom application is being written to communicate with Hydronix sensors over the Ethernet, then the Hydro-Link communications protocol should be implemented and the resulting message string sent over the network to the Ethernet Adapter (instead of a serial port). In Visual Basic (VB6) this is done using a WinSock control and in Visual Studio .NET this can either be done using a Sockets control or a TCP Client control. A connection should be made from the Winsock or TCP Client control to port 10001 on the Adapter.



Further information on these controls can be found in the programming system documentation. Although Hydronix is able to provide guidance they may be unable to give detailed technical support for developing custom software applications.

Hydronix are currently developing a Class Library for .NET to implement all of the communications functionality including support for the Ethernet Adapter, which will be available upon request. For details of this and more information on the Hydro-Link Communications Protocol please contact Hydronix Technical Support (support@hydronix.com)

1 Introduction

The serial port of a Hydro-Control VI unit may be connected to the RS232 port of an Ethernet Adapter to allow remote access to recipe configuration and mix logs.

This cannot be done while an Adapter is communicating with sensors, as a different communications protocol is used. Installation will be similar to one of the options described in the previous chapter, except that the RS232 Tx, Rx and GND signals will be connected to the Hydro-Control VI unit.

2 Installation

Depending on the installation option chosen, the system should be set up as shown in the diagrams below. Terminal identification for each module is shown later in this chapter.

In order to maintain compliance with the relevant product directives, this equipment should only be installed and used with the approved components supplied by Hydronix. Unauthorized modifications to these units could void the units compliance and invalidate the users right to use the equipment.

2.1 Ethernet Adapter Only

The most basic setup uses only the Ethernet adapter and is arranged as shown below:

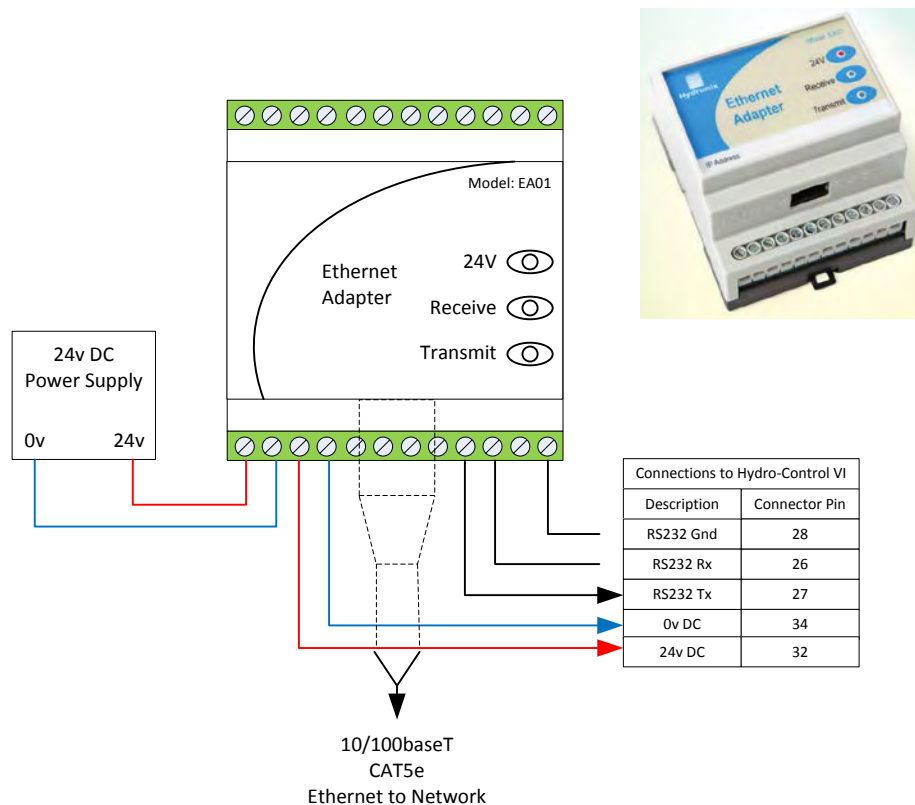

Figure 5: Connecting the Ethernet Adapter to Hydro-Control VI

2.1.1 Location of the Ethernet Adapter (EA01)

The Ethernet Adapter should be mounted in the wiring junction box as close to the Hydro-Control VI as possible, and protected from water and excessive dust. Connect the Ethernet drop cable from the network connection to the Ethernet port of the Adapter. Connect a 24V dc supply to the 24V+ and 0V input terminals of the Ethernet Adapter, ensuring that the power supply and wire is of a sufficient power rating to carry the power for the number of sensors connected.

2.2 Power over Ethernet (EPK01)

A single Hydro-Control VI unit (with attached Hydro-Mix sensor) can be powered using the Power over Ethernet kit. Connect one of the Sensor 24V and 0V connections to the Hydro-Control VI power input pins. The arrangement is as shown below:

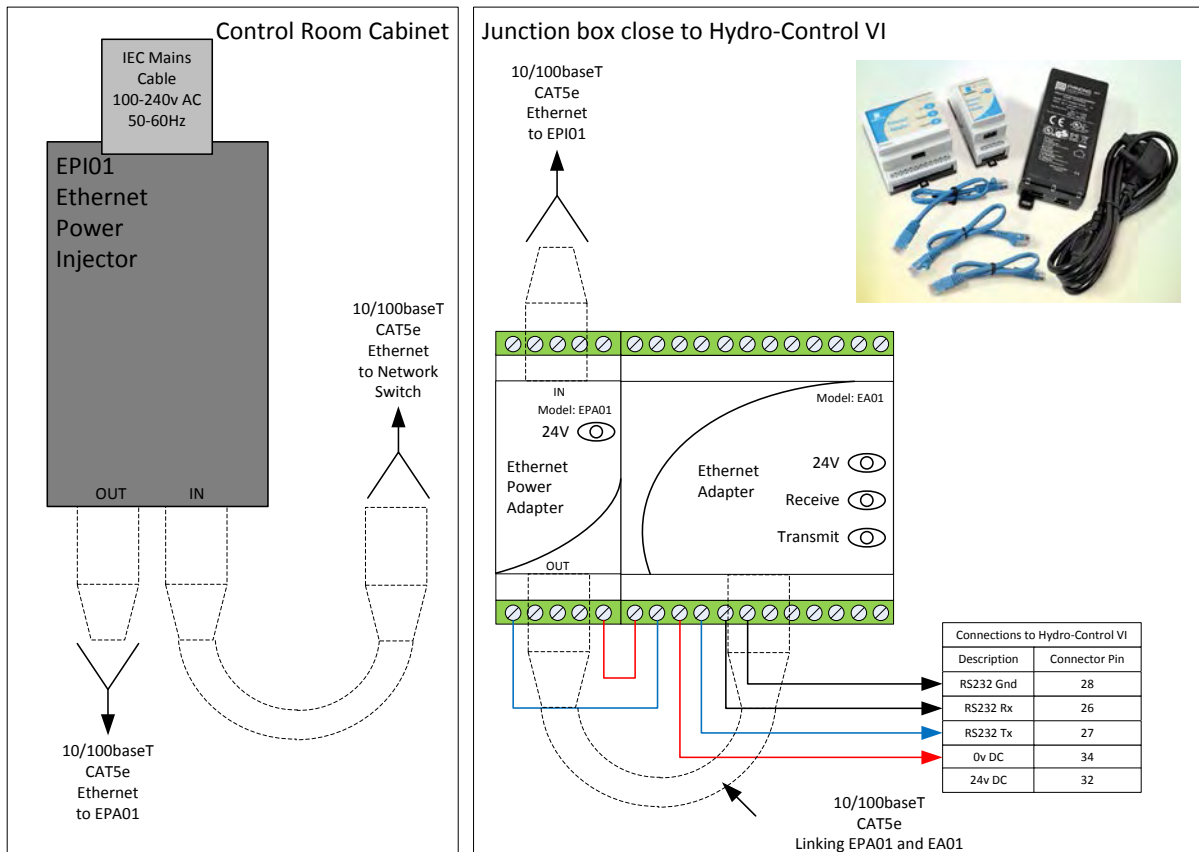

Figure 6: Connecting the Ethernet Adapter to Hydro-Control VI with Power Over Ethernet Option

2.2.1 Location of the Power Adapter (EPA01)

The Power Adapter Module (EPA01) should be mounted in the wiring junction box with the Hydro-Control and beside the Ethernet Adapter, protected from water and excessive dust. Connect the Ethernet drop cable from the router to the IN port of the Power Adapter. This cable carries both the power and the Ethernet communications signals. Connect a short Ethernet cable from the OUT port of the Power Adapter to the Ethernet port on the Adapter. This cable carries only the Ethernet communications. Connect short insulated wires from the 24V+ and 0V outputs of the Power Adapter to the 24V+ and 0V inputs of the Ethernet Adapter, ensuring that the wire is of sufficient power rating to carry the power for the Hydro-Control VI and it's sensor.

Connect RS232 cables between the Ethernet Adapter and the Hydro-Control VI.

2.2.2 Location of the Power Injector Module (EPI01)

The Power Injector Module (EPI01) should ideally be located in the computer room or network cabinet close to the router. Identify which drop cable runs to the Hydro-Control's location, and using a short patch cable insert the Power Injector into that cable, connecting the port labelled IN to the router output and the port labelled OUT to the drop cable. Connect a 240V or 110V mains supply to the Power Injector.

Note: *The Power Injector Module can supply sufficient power for a Hydro-Control VI and a sensor attached to it.*

2.2.3 Ethernet Adapter Hydro-Control VI connections

Ethernet Adapter Terminal	Signal Description	Signal Function	Hydro-Control VI Pin
3	24V + to sensor	24v to Hydro-Control VI	31
4	0v to sensor	0v to Hydro-Control VI	33
8	RS232 RTS	RS232 Ready To Send	Not used
9	RS232 Tx	Data from Ethernet Adapter to Hydro-Control VI	26
10	RS232 Rx	Data from Hydro-Control VI to Ethernet Adapter	27
11	RS232 CTS	RS232 Clear To Send	Not used
12	RS232 GND	Ground connection	28

3 Connecting with Hydro-Control VI

To communicate with a Hydro-Control VI unit, start a terminal emulation program such as HyperTerminal and set the connection properties as shown, substituting the correct IP Address. Note specifically that the Port number should be set to 10001.

The same “ * “ commands can be used as would normally be used over a serial link, and the responses will provide the same information. Refer to the Hydro-Control VI Users Guide for more details of the commands available

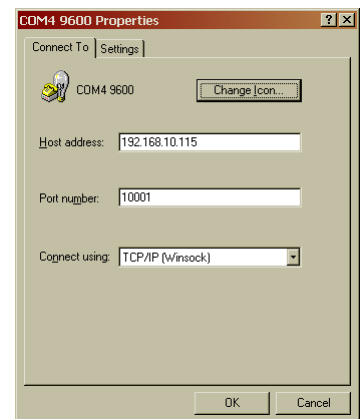

1 Ethernet Adapter defaults

By default, the Ethernet Adapter will use an automatically generated IP Address, which will be allocated by the network DHCP server. As this may change after a few days or weeks, it is recommended that a fixed IP Address is used for the Ethernet Adapter. The allocated address should be on the same subnet as the address allocated by DHCP, but outside the range of DHCP addresses. Contact the Network Administrator to find a suitable address.

2 Finding an Ethernet Adapter automatically

Communication with Hydronix sensors is carried out with the Hydro-Com Utility. To start go to the Communications->TCP/IP menu in Hydro-Com and select "Search for Ethernet Adapters".

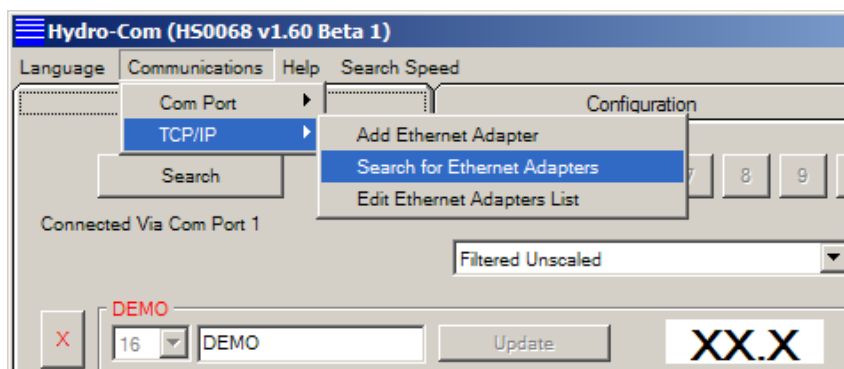

The program will display a search window and query the network for any sensors attached.

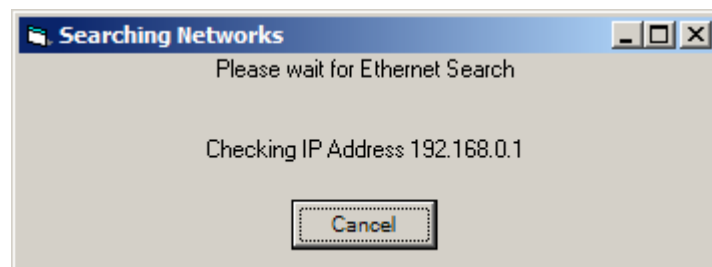

The adapter will be added to the list, select it to connect.

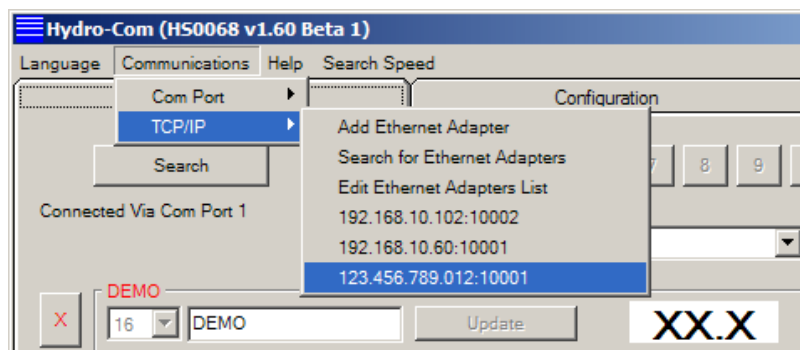

3 Adding an Ethernet Adapter manually

In order to manually enter an Ethernet Adapter's IP Address select Communications->TCP/IP->Add Ethernet Adapter.

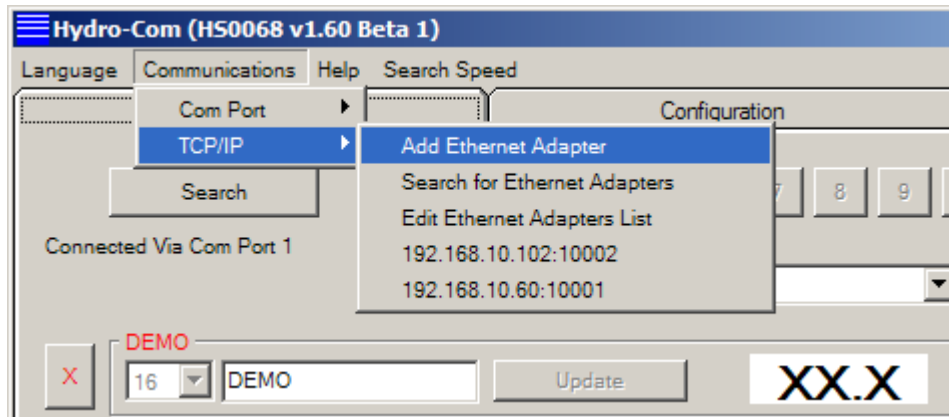

In the dialog that is shown, enter the IP Address and Port Number (usually 10001) of the Ethernet Adapter

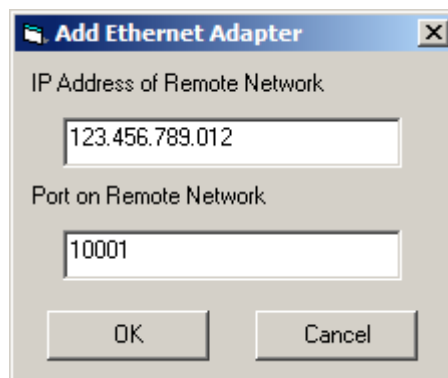

The adapter will be added to the list, select it to connect.

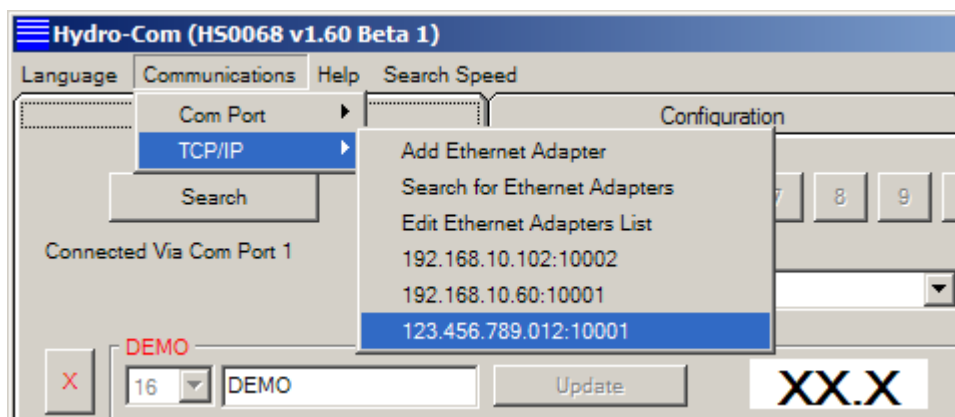

4 Changing the Ethernet Adapter IP Address

Once Hydro-com is connected to an Ethernet Adapter, go to the “Diagnostics” tab, login then click on the button “Settings” in the Ethernet Adapter frame

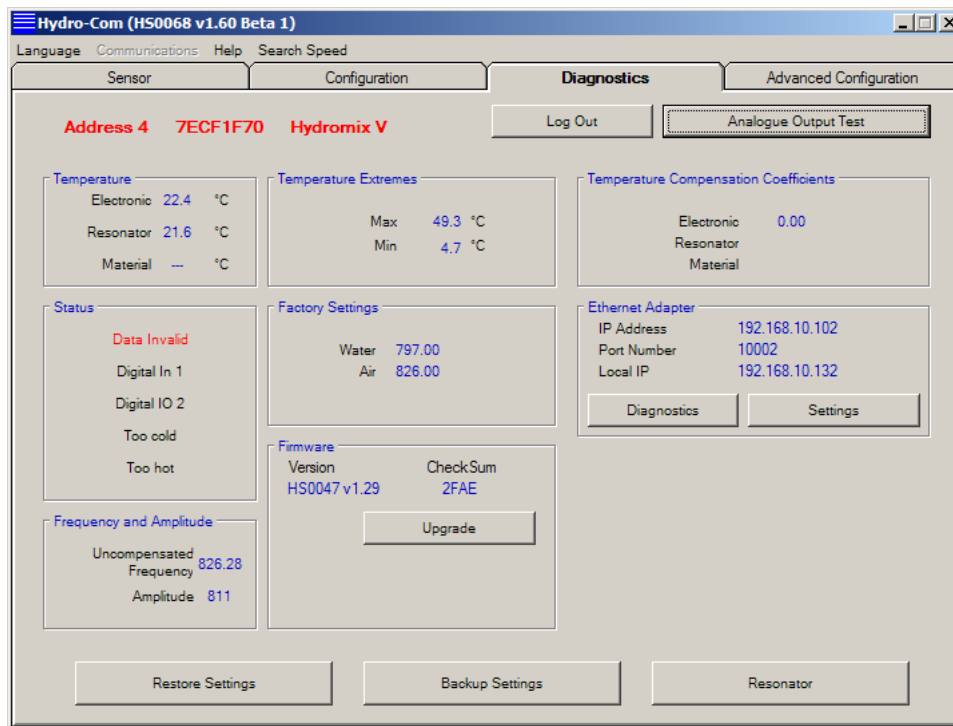

To fix the IP Address, click on “Use fixed IP Address” and enter the IP Address in the box provided. It is recommended to leave the Port Number and Gateway set to the defaults. Click “Set” and then after the progress bar has completed and the new information has been written, click “Exit” to close the dialog and go back to the main screen.

When a fixed IP Address has been assigned, it is recommended to write the address on the front of the Ethernet Adapter in the space provided.

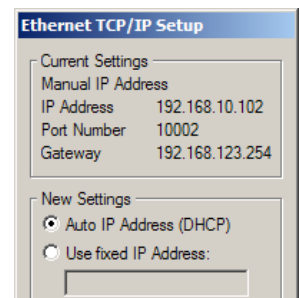

5 Remote (Internet) Connection

Sensors connected to an Ethernet Adapter can also be accessed remotely over the Internet. In order to do this, it is necessary to open up a port in the Firewall of the network on which the Ethernet Adapter is installed. Contact the Network Administrator for details of doing this. When opening the Port, all incoming traffic to that port should be directed to the IP Address of the Ethernet Adapter and port 10001. Make a note of the network’s IP Address on the Internet and the number of the port opened up. The table below shows the settings used in this example:

Company Network Settings		Ethernet Adapter Settings	
IP Address	Opened Port	IP Address	Port Number
123.456.78.901	7011	192.168.10.61	10001

The port 7011 on the Firewall is opened up and all traffic to this port is forwarded to 192.168.10.61 port 10001.

If the Firewall does not allow a completely flexible configuration of port forwarding then either open up port 10001 on the Firewall and leave the Ethernet Adapter port set as 10001, or alternatively alter the port of the Ethernet Adapter to be the same as the port opened in the Firewall. This is done by entering the new value in the Port Number box when setting the fixed IP Address:

Certain port numbers are reserved for internal use by the Ethernet Adapter and should not be used:

Port Number	Function
1 – 1024	Commonly used Internet Ports
9999	Ethernet Adapter Reserved functionality
14000 – 14009	
30704	
30718	

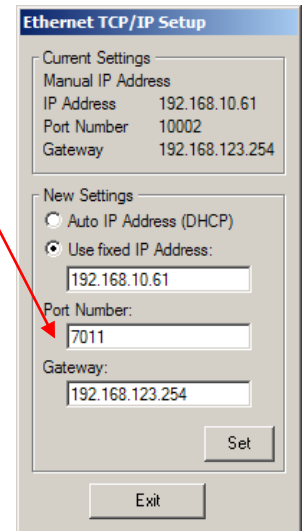

Hydro-Com prevents you from setting these port numbers.

Install Hydro-Com on the remote machine. As before, select Communications->TCP/IP->Add Ethernet Adapter. In the Add Ethernet Adapter window, enter the IP Address of the Firewall and the Port opened.

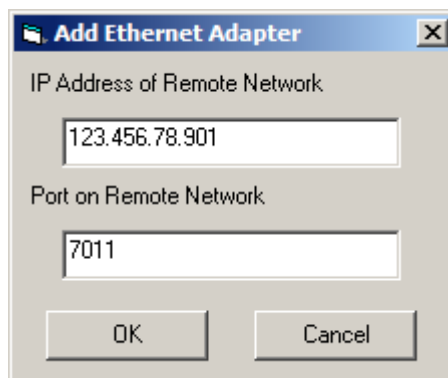

1 EA01 Ethernet Adapter

Dimensions: 70mm (w) x 86mm (h) x 57mm (d)

Environment: Operating Temperature 0-70°C

Modules should be used indoors in dry environments only. The enclosures are rated to IP31.

Interfaces: Ethernet IN: Standard 10/100baseT Ethernet RJ45 socket

RS485: Can connect to a maximum of 16 Hydronix Sensors

RS232: Standard RS232 interface

Weight: 160g

2 EPA01 Ethernet Power Adapter

Dimensions: 35mm (w) x 86mm (h) x 57mm (d)

Environment: Operating Temperature:0-70°C

Modules should be used indoors in dry environments only. The enclosures are rated to IP31.

Power Output: 24V, 630mA – see notes in Chapter 2 on number of sensors that can be powered.

Interfaces:Ethernet IN: Standard 802.11af 10/100baseT Power over Ethernet RJ45 socket

Ethernet OUT: Standard 10/100baseT Ethernet RJ45 socket

Weight: 123g

3 EPI01 Ethernet Power Injector

Dimensions: 65mm (w) x 140mm (h) x 36mm (d)

Environment: Operating Temperature: 0-40°C

Modules should be used indoors in dry environments only.

Interfaces:Mains In: IEC320 inlet 3 pin

Ethernet IN: Standard 10/100baseT Ethernet RJ45 socket

Ethernet OUT: Standard 802.11af 10/100baseT Power over Ethernet RJ45 socket

Weight: 246g

NOTE: Allow space for cables to be fitted on all units

4 Terminal Identification

The Ethernet Adapter terminals are wired as follows:

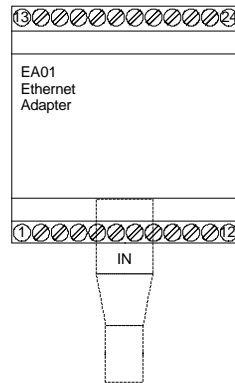

Figure 7: EA01 Terminal Identification

Ethernet Adapter Terminal	Signal Description	Notes
IN	CAT5e Network cable	
1	24V + input	
2	0V input	
3	24V + to sensor	
4	0V to sensor	
5	RS485 B	
6	RS485 A	
7	No connection	
8	RS232 RTS	
9	RS232 Tx	
10	RS232 Rx	
11	RS232 CTS	
12	RS232 GND	
13	24V + to sensor	It is not recommended to wire RS485 using a star topology Please refer to chapter 2 on RS485 wiring recommendations
14	0V to sensor	
15	RS485 B	
16	RS485 A	
17	24V + to sensor	

18	0V to sensor	
19	RS485 B	
20	RS485 A	
21	24V + to sensor	
22	0V to sensor	
23	RS485 B	
24	RS485 A	

The Ethernet Power Adapter EPA01 terminals are wired as follows. Particular care must be taken to identify the top and bottom of the unit, as both sides look similar.

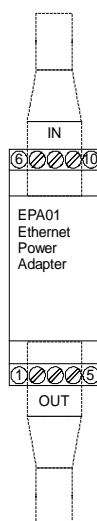

Figure 8: EPA01 Terminal Identification

Ethernet Power Adapter Terminal	Signal Description
IN	CAT5e Network cable from EPI01
OUT	CAT5e Network cable to EA01
1	0V output
2	0V output
3	No connection
4	24V + output
5	24V + output
6	0V output
7	0V output

8	No connection
9	24V + output
10	24V + output

1 Ethernet Adapter EA01

Symptom: 24V light not on

Possible Explanation	Check	Required Result	Action required on failure
24V not connected	DC power on terminals 1 and 2	+24v DC	Locate fault in power supply

Symptom: Not found on network using the Hydro-Com Search function

Possible Explanation	Check	Required Result	Action required on failure
Not connected to network	Ethernet link	Ethernet link light lit	Locate fault in network cabling
No DHCP address	DHCP server	IP address assigned	Unplug and replug the network cable

2 Ethernet Power Adapter EPA01

Symptom: 24V light not on

Possible Explanation	Check	Required Result	Action required on failure
Ethernet Power Injector not connected	Ethernet Power Injector EPI01 as above	24V light on	
Ethernet cables plugged in wrong way round	Try swapping the cables – the Power Injector should go to IN and the OUT should go to the Ethernet Adapter	24V light on	

Symptom: Computer does not communicate with the Ethernet Adapter

Possible Explanation	Check	Required Result	Action required on failure
Not properly registered on network	Search for the Ethernet adapter using the Hydro-Com 'Search' function. If that fails then try pinging the IP address of the Ethernet Adapter	Ethernet Adapter found Ping response	Investigate network – try power cycling EA01 Check IP Address
Invalid IP address	If the subnet mask is 255.255.255.0 then if	Connection from Hydro-Com to Ethernet	Contact local network administrator or

	the adapter's IP address x.y.z.a then the PC's must be x.y.z.b (b <> a) try changing the PC's to match and try again	Adapter – then the IP Address can be changed	Hydronix Technical Support
--	--	--	----------------------------

Symptom: Computer does not communicate with the sensor

Possible Explanation	Check	Required Result	Action required on failure
Not wired correctly to sensor	Wiring connections of EA01	Transmit and receive lights blink	Check sensor connections, try a different sensor

3 Ethernet Power Injector EPI01

Symptom: ON light not illuminated

Possible Explanation	Check	Required Result	Action required on failure
Ethernet Power Injector not plugged in	Power supply to Ethernet Power Injector	ON light illuminated	Try a different EPI01

Symptom: CONNECT light not illuminated

Possible Explanation	Check	Required Result	Action required on failure
Ethernet cable to Ethernet Power Adapter faulty or not connected	Cable between EPI01 and EPA01	CONNECT light illuminated	Replace cable or try a different EPA01



Hydronix Limited
 7 Riverside Business Centre
 Walnut Tree Close
 Guildford
 Surrey
 United Kingdom



Tel: +44 1483 468900
 Fax: +44 1483 468919

Declaration of Conformity

We **Hydronix Limited**
 of **7 Riverside Business Centre, Walnut Tree Close, Guildford, Surrey,
 GU1 4UG, United Kingdom.**
 Declare that:
 Equipment: **EA01 and EPA01 - together EPK01**
 Model name/number: **Ethernet Adapter and Ethernet Power Adapter**
 Have been designed and manufactured to the following specifications:

Radiated Emissions	EN55022 Class A and Class B	FCC Part 15
Conducted Emissions	EN55022 Class A	FCC Part 15
Radiated Immunity	EN55024	
Conducted Immunity	EN55024	

Based on testing reported in document HD0347 on 4 October 2007.

	
<p>This device complies with part 15 of the FCC Rules. Operation is subject to the following two conditions:</p> <p>(1) This device may not cause harmful interference, and</p> <p>(2) This device must accept any interference received, including interference that may cause undesired operation.</p> <p>Unauthorized modifications to these units could void the unit's compliance and invalidate the user's right to use the equipment.</p>	<p>This device is designed and manufactured in accordance with the following directives:</p> <p>89/336/EEC The Electromagnetic Compatibility Directive and its amending directives</p>

I hereby declare that the equipment named above has been designed to comply with the relevant sections of the above referenced specifications. The unit complies with all the essential requirements of the Directives.

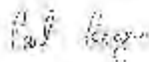

Paul Rogers
 Technical Director
 Date: 24 January 2008

Index

Connections	17	Ethernet Power Adapter.....	16
Internet / Remote.....	27	Hydro-Control V	21
Custom Application	19	Interfaces	
Defaults	25	Ethernet Adapter.....	29
DHCP	25	Ethernet Power Adapter.....	29
Dimensions.....	29	Ethernet Power Injector	29
Ethernet Adapter		Internet Connection.....	27
Connections	30	IP Address	25
Connections for Sensor.....	17	Kit Options	11
Defaults	25	Number of Sensor Connections.....	16
Fault Finding.....	33	Operating Temperature.....	29
Hydro-Control V Connections	23	Port Numbers.....	28
Indicator Lights	18	Power Injector Module	
Installation	15	Sensor Connections.....	23
IP Address	25	Power Output.....	29
Location	15, 22	Power over Ethernet	
Terminals.....	30	Installation	16, 22
Ethernet Adapter Kit		Programming	
Contents	11	Sensors	19
Ethernet Power Adapter		Remote Access.....	27
Connections	18, 31	Remote Connection	27
Fault Finding.....	33	RS-485	
Indicator Lights	18	Wiring	18
Location	16, 22	Sensors	
Number of Sensors	17	Connections	17
Terminals.....	31	Ethernet Adapter Location	15
Ventilation.....	16	Ethernet Power Adapter.....	16
Ethernet Power Adapter Kit		Installation	15
Contents	11	Number of Sensors	16
Ethernet Power Injector		Programming.....	19
Fault Finding.....	34	TCP/IP Menu	25
Indicator Lights	18	Temperature	29
Location	17, 23	Number of Sensors	16
Hydro-Control V		Terminal Identification.....	30
Connections	21, 23	Ventilation	16
Ethernet Adapter Location.....	22	Weight.....	29
Ethernet Power Adapter	22	Wiring.....	17
Installation	21	RS-485	18
Hydro-Link	19		
Indicator Lights	18		
Installation	15		
Ethernet Adapter	15		